

V | VALCO

LEADING EXPERT IN VALVES SOLUTIONS

2020



Business Overview



45 M€
turnover



250
employees



4
brands
(GUICHON, MALBRANQUE,
SNRI, VVS)



20 000
valves per year
(capacity)



49
international agents



3
manufacturing
plants in France

Sales figure (in M€)

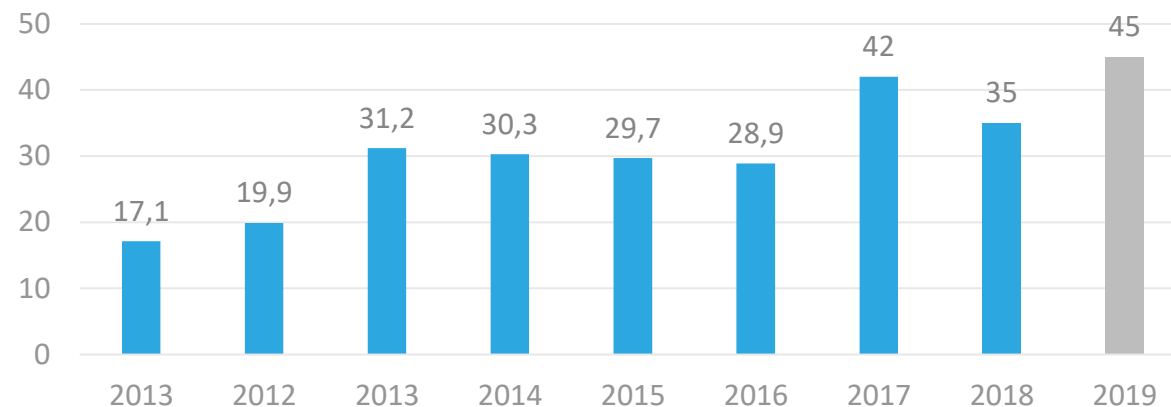

Sales sectors 2018

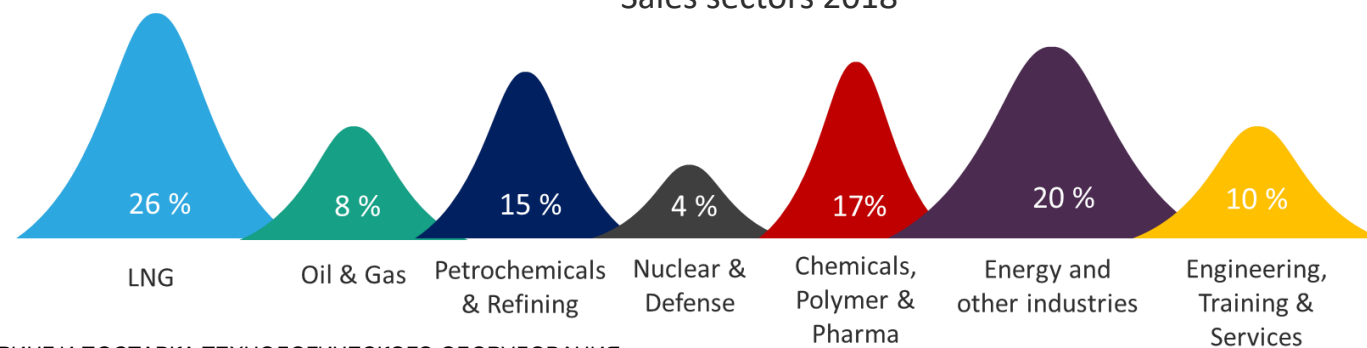

Structure of Valco Group

“Leading expert in valves solutions”



Our History

1968

Sergot & Seguin merged and SERSEG was created to supply the nuclear market

1990

SNRI SERVICES creation

2003

Malbranque joined TECHNOR GROUP (exit of Royal Econosto)

2015

GUICHON joined the VALCO GROUP

2017

New sales strategy and sales network improvement

1949

Malbranque & Sergot creation

1973

SCHLUMBERGER bought Malbranque and SERSEG

2000

SNRI joined the TECHNOR GROUP

2009

VALCO GROUP FRANCE Creation (SNRI, MM & VVS)

2016

New VALCO GROUP synergies

2018

New visual identity & 2021 strategy



ООО «ТИ-СИСТЕМС» ИНЖИНИРИНГ И ПОСТАВКА ТЕХНОЛОГИЧЕСКОГО ОБОРУДОВАНИЯ
 Интернет: www.tisys.ru www.tisys.kz www.tisys.by www.tesec.ru www.ti-sistems.com
 Телефоны: +7 (495) 7774788, 7489626, (920) 5007155, 54 66 Эл. почта: info@tisys.ru info@tisys.kz info@tisys.by

Sales sectors

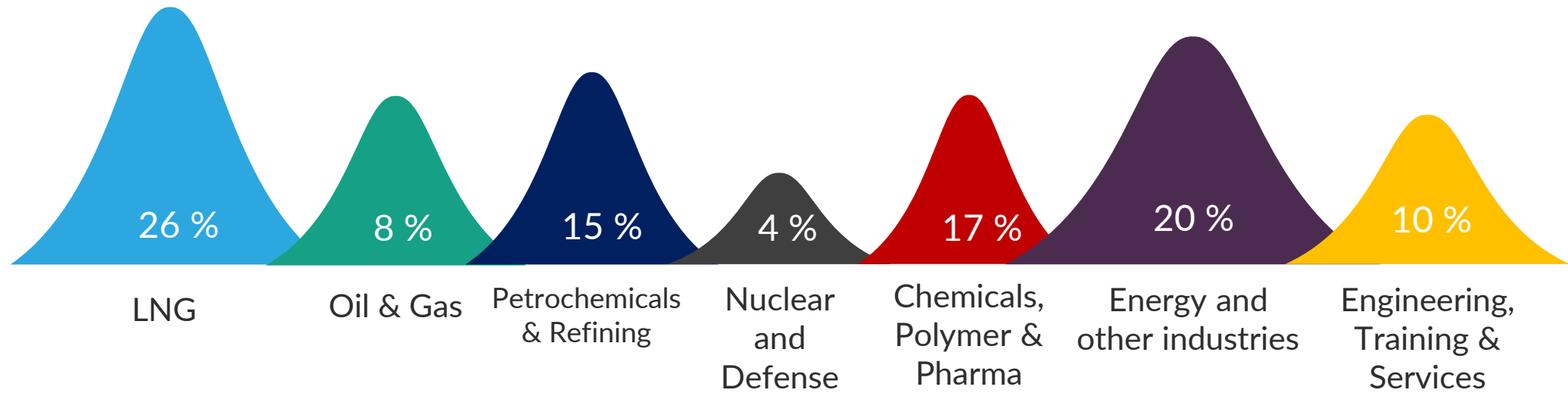

Awarded Projects

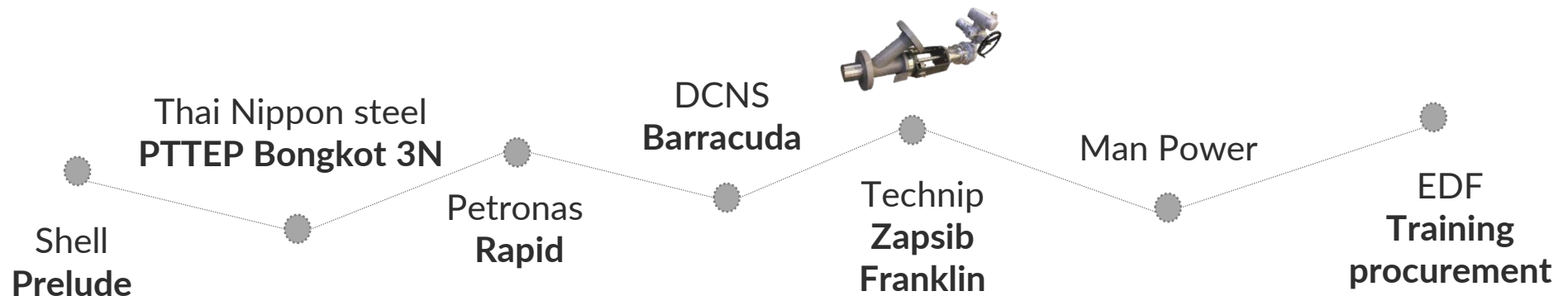

International sales network



- 63 Agents and/or distributors
- 55 countries
- **2 main factories**

ООО «ТИ-СИСТЕМС» ИНЖИНИРИНГ И ПОСТАВКА ТЕХНОЛОГИЧЕСКОГО ОБОРУДОВАНИЯ
Интернет: www.tisys.ru www.tisys.kz www.tisys.by www.tesec.ru www.ти-системс.рф
Телефоны: +7 (495) 7774788, 7489626, (925) 5007155, 54, 65 Эл. почта: info@tisys.ru info@tisys.kz info@tisys.by

Our French facilities



SNRI - Malbranque - VVS

Ruffec plant : 270 employees
14000 m² of workshop, offices,
storage



Guichon Valves

Chambéry plant : 90 employees
6000 m² of workshop, offices,
storage

Our French facilities



Our range of products



Globe Valves

Gate Valves



+ Extreme applications

+ Safety & High Pressure Valves

+ Cryogenic Valves



Carbon steels or low alloy steels



Austenitic or super austenitic Stainless Steel (304, 316, 321, Uranus B6...)



Duplex steels



Nickel and nickel alloys (Alloy 20, Hastelloy, Inconel, Incoloy, Monel...)



Check Valves



2" to 42"

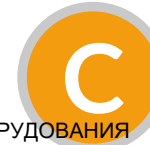

900 to 2500 lbs

Our range of products

MALBRANQUE
HIGH PERFORMANCE VALVES



Globe Valves

Gate Valves



- + Extreme applications
- + Safety & Emergency Valves
- + High Pressure (PSB valves)



Carbon steels or low alloy steels



Austenitic or super austenitic Stainless Steel (304, 316, 321, Uranus B6...)



Duplex steels



Nickel and nickel alloys (Alloy 20, Hastelloy, Inconel, Incoloy, Monel...)

10
Ten millions
of worldwide
references



2" to 72"



150 to 2500 lbs

Our range of products



Special and custom-made valves (all technologies)



- + Sampling Valve
- + Multiway Valve
- + Tank Bottom Valve
- + Jacketed Valve
- + Piston Valve

+ Chemistry

+ Petrochemicals

- + Slide Valve
- + Transfer Line Valve (TLV)
- + Ball, Gate, Globe, Check Valve
- + Actuators

+ Plastics & Polymers



Carbon steels or low alloy steels



Austenitic or super austenitic Stainless Steel (304, 316, 321, Uranus B6...)



Nickel and nickel alloys (Alloy 20, Hastelloy, Inconel, Incoloy, Monel...)



Duplex steels



Special alloys (Titanium, Zirconium, Tantalum...)



2" to 42"



150 to 2500 lbs

We never let your performance down

Our on-site intervention company – Maximizing operation time



Expertise



01

Maintenance



02

On site Retrofit



03



Sale support & Supervision

VVS (Valco Valve Services) has the qualification and experience to provide commissioning, repair and maintenance services for valves supplied to all Valco and non-Valco customers, whatever the valve brand is.

A dedicated team of specialists is available for on-site service anywhere in the world. The team also holds permits and certifications for servicing valves installed in nuclear sites.

VALCO is also 4.0 oriented : Our smart glasses can be kept by your maintenance staff on plant and used to contact our technical specialists. Easier, faster and cheaper maintenance is a shared goal with our customers.

VVS Team



Our services

Training

(in house and on-site specific training)

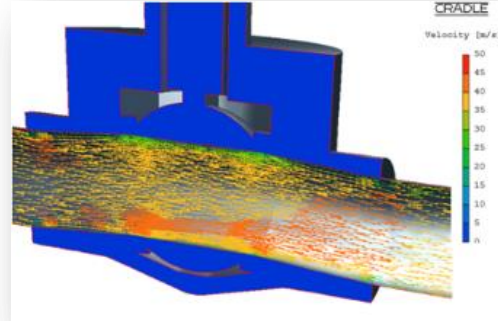

Technical studies

(flow and thermal simulations, design, drawings & mechanical strength analysis)

Auditing & Aftermarket

(audit, maintenance & valve management system)

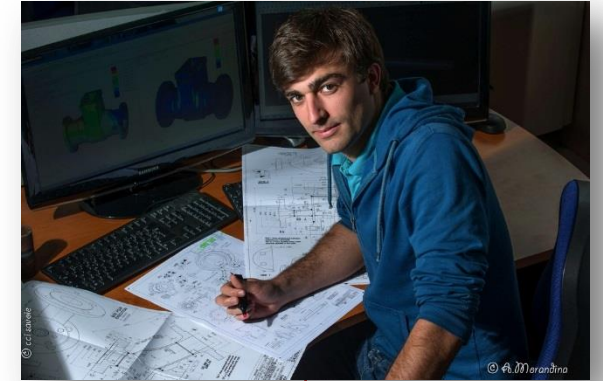

Consulting

(engineering, project management, purchases, start-up & commissioning)

Main customer typology

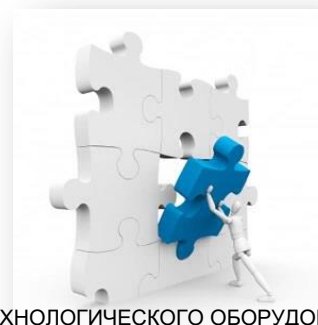
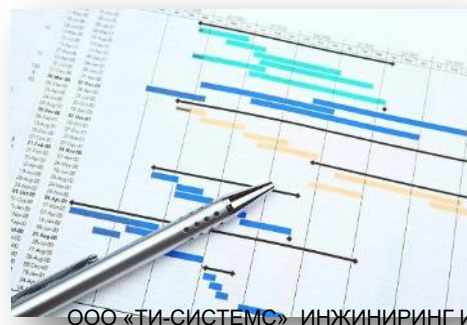
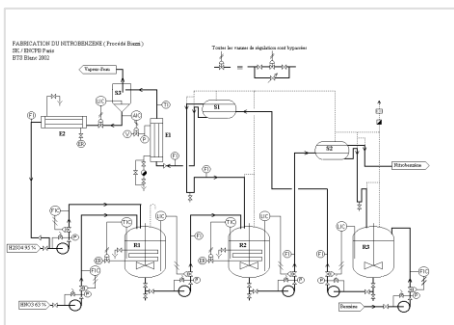
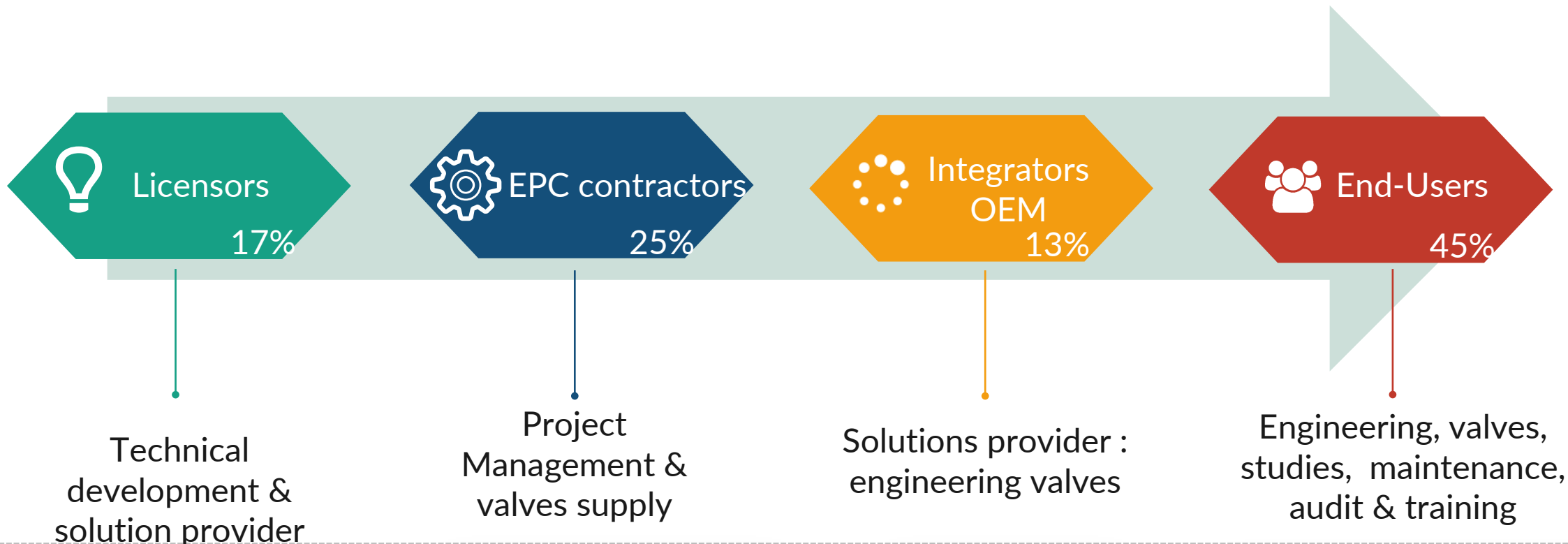

They trust us



Certification & quality assurance

Construction codes and standards

- ASME CODE –Section VIII and / ANSI B 31.3
- ASME U-STAMP
- ASTM Materials
- API 597
- API 598
- API 6D
- API 600
- API 603
- API 605
- ANSI B 16.34
- ANSI B 16.5
- ANSI B 16.10
- CU TR (Russian cert.)
- BS 1414
- BS 1868
- BS 1873
- BS 3293
- BS 6755
- BS 6364
- CODAP
- MASE
- MSS
- NACE MR 01.75
- RCC-M
- RCC-Mx
- RRCM-H Revision 3
- AD2000
- API specification Q1



PED
2014/68/EU



and more

VALCO

LEADING EXPERT IN VALVES SOLUTIONS



Chemin du Treuil
16700 Ruffec - FRANCE



Follow us :



ООО «ТИ-СИСТЕМС» ИНЖИНИРИНГ И ПОСТАВКА ТЕХНОЛОГИЧЕСКОГО ОБОРУДОВАНИЯ
Интернет: www.tisys.ru www.tisys.kz www.tisys.by www.tesec.ru www.ти-системс.рф
Телефоны: +7 (495) 7774788, 7489626, (925) 5007155, 54, 65 Эл. почта: info@tisys.ru info@tisys.kz info@tisys.by